

Scope Evaluation Guide & Circuit Board Instructions

ronix 2440

500MS/s DIGITAL
OSCILLOSCOPE

GPIB STATUS

LOCK SRQ A

500mV

A 20ns

383mV VE

500mV

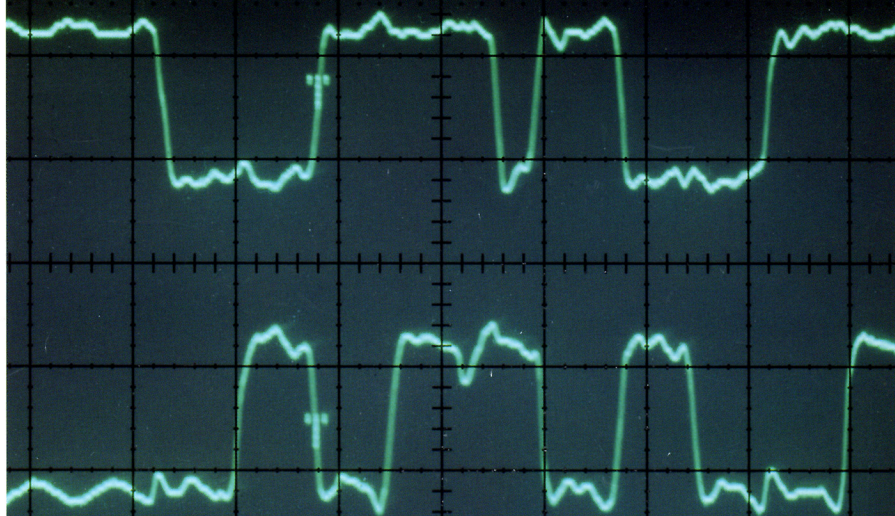

WIRE

1

8

REPET SAVE ON

NORMAL ENVELOPE

AUG

ON | OFF ON | OFF

Fast, Easy Answers to Scope Evaluation Questions

If you're evaluating a new 100 MHz to 500 MHz Digitizing Storage Oscilloscope (DSO), no matter what it looks like on paper, what counts is performance.

This Scope Evaluation Guide and Circuit Board tester will help you cut through the flashy specs and see for yourself how well the scope captures, processes and displays real-world signals—helping you pick the right scope for your application needs.

Using this Evaluation Guide you can:

- Attach probes to the miniature Circuit Board
- Set up the oscilloscope following easy instructions
- Compare your results with photos of waveforms displayed on DSOs of proven performance

The board works equally well with analog or digitizing oscilloscopes.

Instructions for getting started

1. Reverse the battery and snap it into the test board socket.
2. Turn on the scope.
3. Make sure the probe is properly compensated. (Some oscilloscopes offer a calibration signal on the front or rear panel.)

Circuit Board Tester

TP1—Squarewave output from a 4-bit counter. The signal has a fast risetime (around 2 nsec*) and some overshoot like that found in any digital system. It's important that your scope has a high enough bandwidth (high bandwidth yields fast rise time) to let you see and measure the signals you encounter in your application. You can also use this Test Point to see whether the scope you are evaluating shows you the signal as it really is.

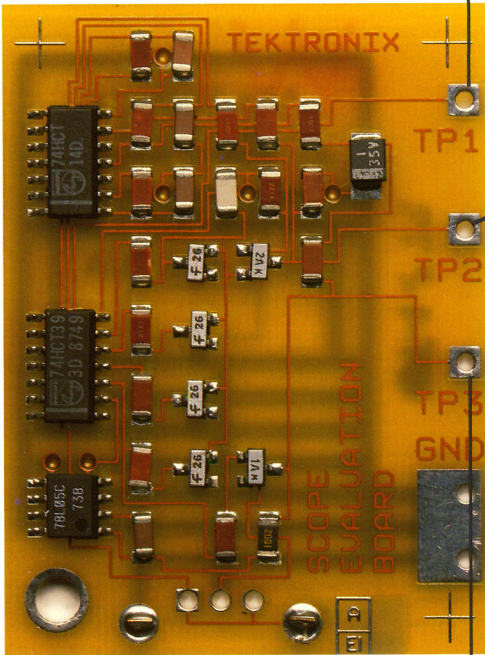

TP2—This signal is the stairstep-shaped output of a 4-bit DAC (digital-to-analog converter). As in practical systems, there is high-frequency noise on this signal and several narrow glitches. This is a challenging signal on which to trigger any scope. Glitches like those on this signal could cause system failures if they were hiding in the circuits you work with. Your scope could save weeks of troubleshooting if it could be counted on to catch these important events.

TP3—If you are using a scope to make adjustments or perform calibrations, you need to see instantly the effects of these changes. The amplitude of the 1.2 MHz* squarewave on TP3 varies by 1 volt* at a 15 Hz* rate. A scope should be responsive enough to show you this amplitude variation.

*Values are typical and may vary from board to board.

1. Will the scope trigger on your signals?

If an oscilloscope can't display a stable waveform on screen, you can't examine the signal.

Setup: Triggering on a noisy signal

Attach the probe tip to	TP2
Set the oscilloscope for:	
Input coupling	DC
Vertical sensitivity (Volts/div)	200 mV/div
Time base (sec/div)	1 ms/div
Trigger:	
Slope (+ or - edge)	- (minus)
Coupling	HF Reject
Level	300 mV

Even a DSO with a high sample rate and high bandwidth is useless without the ability to trigger on the signal you want to examine. For example, signals are seldom "clean", so the DSO must often be able to generate a stable trigger from a noisy signal.

To ensure that you can quickly display a stable waveform on screen, you may need trigger functions such as:

- High-frequency rejection
- Low-frequency rejection
- Noise rejection
- AC/DC coupling
- Video triggering
- Logic triggering

Never overestimate the scope's triggering capability. You cannot safely assume that all scopes will trigger equally well on your signals. You may wish to do further evaluation of such trigger issues as jitter, level readout accuracy, bandwidth, and voltage range.

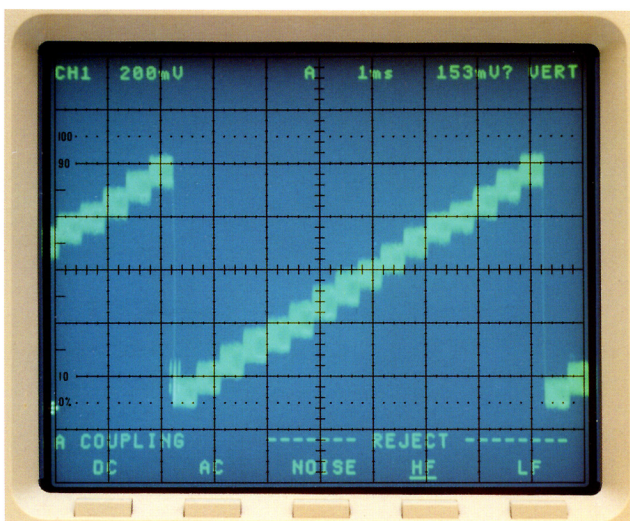

This staircase waveform contains high frequency noise that may prevent triggering. High-frequency-rejection trigger circuits filter out this noise. The user has selected High Frequency Reject on this DSO to get a stable display.

High-frequency noise prevents this DSO from triggering consistently on the negative slope of the waveform since the user has not selected (underlined) the High Frequency Reject feature.

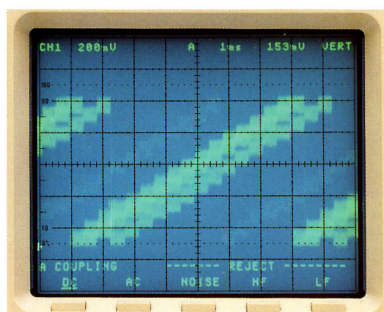

A stable trigger allows the DSO to average signals for higher vertical resolution and less noise, as shown here.

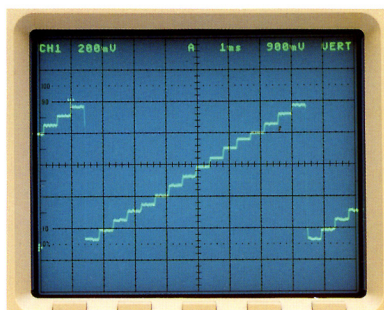

2. Will the scope miss important events?

At slower sweep speeds, a DSO's sample rate is lower than the specified maximum. So there is more time between samples. During this time, critical signal features that you need to know about can be missed without the help of peak detection capabilities.

Setup: Capturing narrow events between samples

Attach the probe tip to	TP2
Set the oscilloscope for:	
Input coupling	DC
Vertical sensitivity (Volts/div)	200 mV/div
Time base (sec/div)	1 ms/div
Trigger:	
Slope (+ or - edge)	+ (plus)
Coupling	HF Reject
Level	300 mV
Acquisition mode	Envelope or Peak Detect

DSOs sample a signal at regular intervals, but what happens to the waveform if the event you want to see occurs *between* sample points? Understanding the behavior of a circuit under test may require capturing a glitch or viewing unwanted high-frequency noise. For example, if your DSO samples every 4 ns, but a 2 ns glitch appears, will you see it? Maybe, maybe not.

Remember that the highest sampling rate is not available on the slower time-base settings unless peak detection capabilities are provided. At micro or millisecond settings, you are probably dealing with kilosample—not megasample—performance. To overcome that problem, special peak detection hardware and firmware can help the DSO acquire and display events between samples.

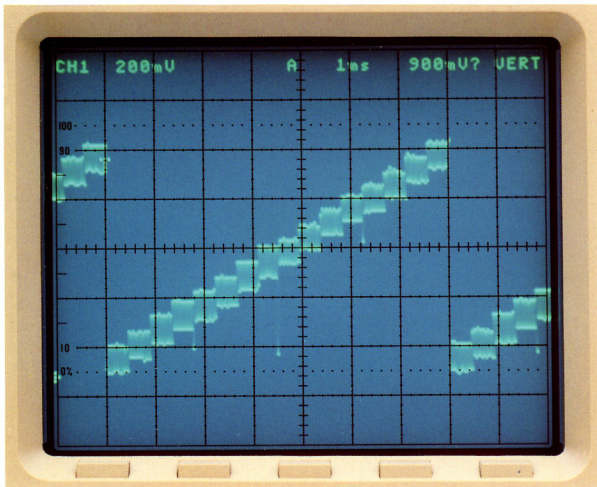

DSOs that have adequate glitch-capture or peak detection capabilities reveal the narrow, negative-going glitches in the test signal.

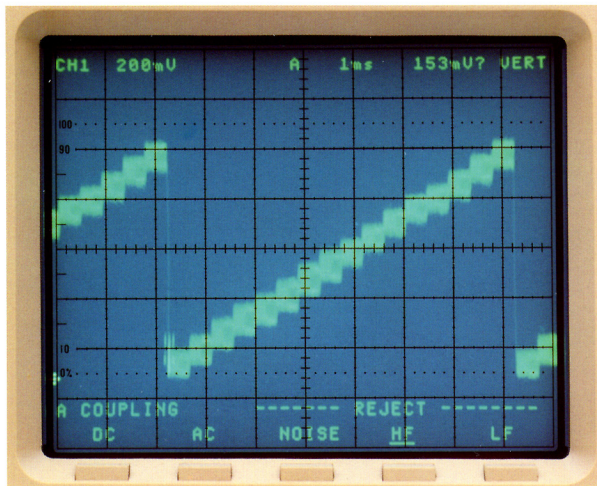

This is the same signal as in the photo above, but the scope is not in a peak-detecting mode.

Will the scope miss events between acquisitions?

If a digitizing scope spends too much time processing data, it can't acquire your signals often enough. While it isn't monitoring the input signal, it could miss those infrequent events that you need to know about. This can also reduce throughput and significantly slow down your entire system.

Setup: Capturing signal variations

Attach the probe tip to	TP3
Set the scope for:	
Input coupling	DC
Vertical sensitivity (Volts/div)	1 V/div
Time base (sec/div)	10 ms/div for top figure opposite 200 μ s/div for bottom figure opposite
Trigger:	
Slope (+ or - edge)	+ (plus)
Coupling	DC
Level	2 V
Acquisition mode	Normal

DSOs acquire data for some period of time, then they spend time processing and displaying the data they have acquired. The number of acquiring/processing/displaying sequences per second is the *update rate*. Analog oscilloscopes have update rates reaching hundreds of thousands of acquisitions per second. The update rate for a DSO ranges from 1 to 100 acquisitions per second.

What happens if the event you want to examine occurs while the DSO is processing earlier data? This gap between acquisitions is a particular problem with infrequent events. You may miss an event altogether, or it may require several hours to capture if the DSO has a low update rate.

Update rate also affects the response time of a DSO, determining whether or not the DSO has a "live" feel.

You might try turning on a few automatic measurements and/or vectors (connect-the-dots) and see if the scope's responsiveness is affected.

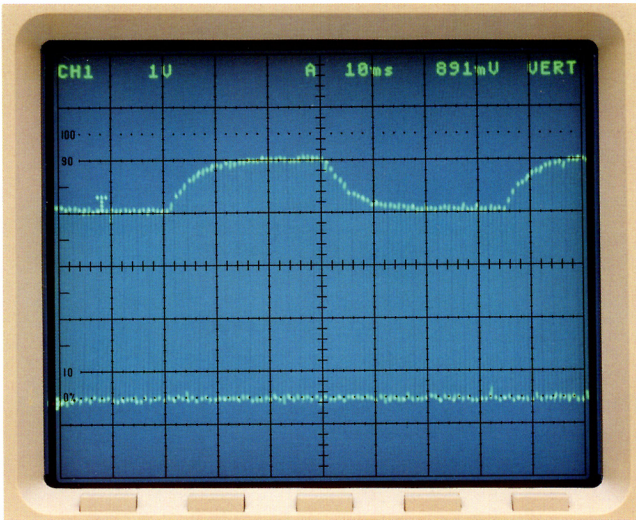

Here the time base setting is 10 ms/division so you can see the overall signal and all the voltage levels for the tops of the pulses. The same signal is shown in the photo below, but at a 200 μ s/division time base setting.

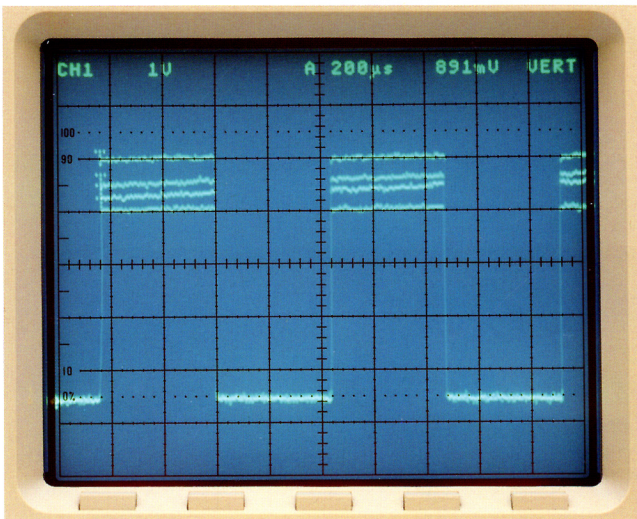

At a 200 μ s/division sweep speed, an analog oscilloscope or a DSO that has a high update rate will reveal the amplitude modulation. A DSO that has a low update rate will show only one or two voltage levels for the tops of the pulses.

3. Will the scope accurately capture and measure your signals?

The major reason people use a scope is to see and analyze their signal. A high quality oscilloscope displays waveforms true to life.

Setup: Faithfully reproducing captured signals

Attach the probe tip to	TP1
Set the scope for:	
Input coupling	DC
Vertical sensitivity (Volts/div)	1 V/div
Time base (sec/div)	2 ns/div (if available, otherwise 5 ns)
Trigger:	
Slope (+ or - edge)	+ (plus)
Coupling	DC
Level	1 V
Acquisition mode	Repetitive sampling mode ON

All DSOs *sample* the signal to be examined. The fidelity of the waveform reconstructed on screen depends on the accuracy of the analog-to-digital conversion process and the performance of the analog circuits in the front end of the scope.

Both analog and digitizing oscilloscopes need to faithfully reconstruct the signal—a basic quality sometimes downplayed in the specifications for DSOs.

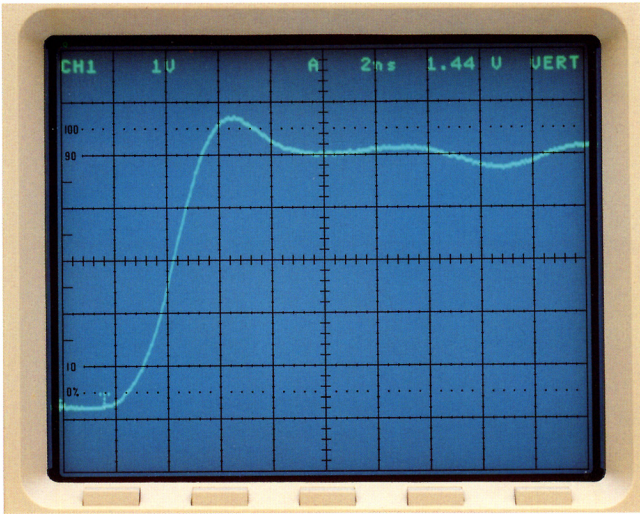

Here the rising edge and front corner of a fast clock pulse are displayed on a high-performance DSO. The oscilloscope you are evaluating should show a similar rise time, overshoot and ringing.

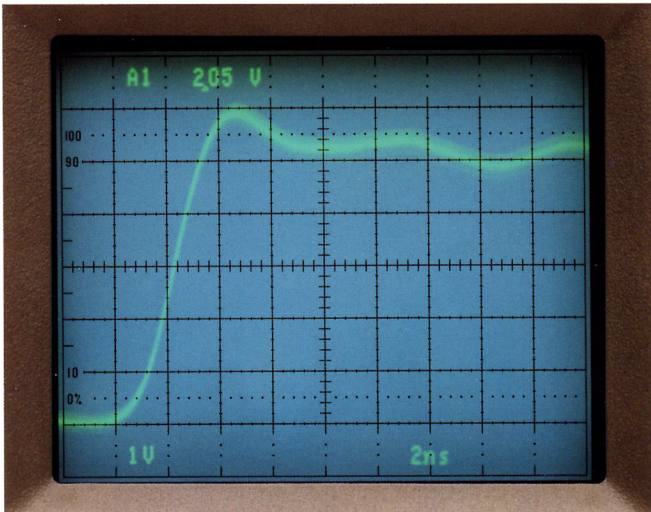

Here the same waveform is displayed on a high-performance analog scope.

Will the scope make accurate measurements?

The quality of the products you design and test depends on your use of accurate and reliable measurement techniques and instruments. A scope should measure up to your standards.

Setup: Making accurate measurements

Attach the probe tip to	TP1
Set the scope for:	
Input coupling	DC
Vertical sensitivity (Volts/div)	1 V/div
Time base (sec/div)	2 ns/div (if available, otherwise 5 ns)
Trigger:	
Slope (+ or - edge)	+ (plus)
Coupling (AC, DC)	DC
Level	1 V
Acquisition mode	Repetitive sampling mode ON

Your success in designing, testing, and troubleshooting circuits may depend on the accuracy of your measurements. If the accuracy is too low or not clearly specified, then you might inaccurately measure timing as well as amplitude values. Accuracy depends on variables such as:

- Vertical resolution
- Amplifier performance
- Horizontal resolution
- Interaction between vertical and horizontal resolution
- Flexibility of automatic measurements

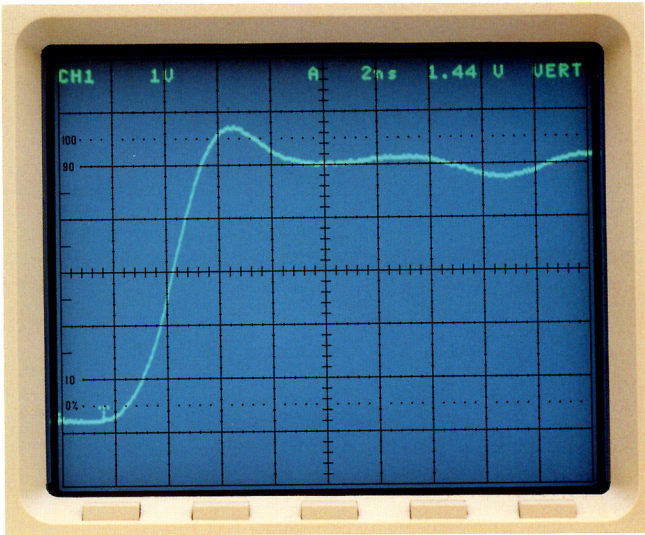

When you make a manual rise time measurement, what levels do you use as 0% and 100% points? You probably—and correctly—look at the overall signal to see where the waveform settled at the base and at the top. Compare your results against the scope's automatic measurements.

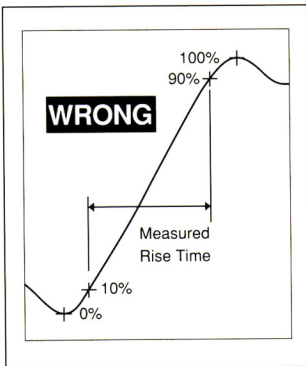

In the waveform on the left, the DSO used min and max values as the 0% and 100% points. Erroneously picking these values caused an error in the rise time measurement.

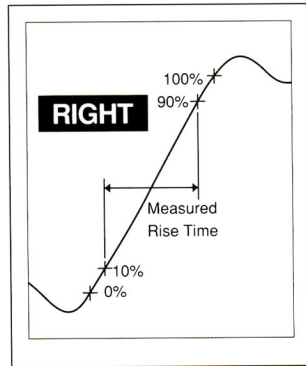

The waveform on the right shows the correct measurement points. The DSO, using the "histogram" measurement method, correctly picked the *settled* portions of the waveform as the 0% and 100% points.

Vertical resolution determines the number of levels displayed on the screen and stored in memory. It also determines the amount of waveform detail that you can see and measure. The more vertical resolution the DSO has, the more accurately you can place cursors and the more precisely you can use the auto measurements.

If the DSO that you are evaluating has low vertical resolution, timing measurements may be inaccurate because the DSO doesn't have enough vertical levels to precisely place the 10% and 90% points.

Eight (8) bits of vertical resolution is the minimum required level for most applications. While "number of bits" is the accepted and preferred specification, you may see vertical resolution specified in percentages:

Bits	Levels	% Resolution of full scale
6	64	1.56%
8	256	0.4%
10	1024	0.1%
12	4096	0.024%

When you are measuring repetitive signals, you can improve vertical resolution by using signal averaging.

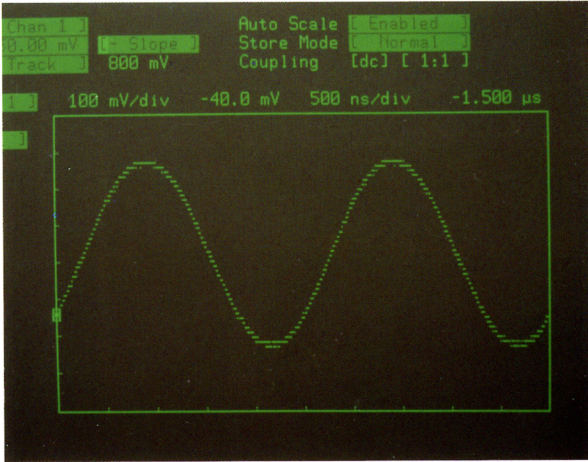

The difference between 6 bits (above) and 8 bits (below) of vertical resolution is dramatically visible between the two waveforms shown. Note the higher visual definition provided by the 8-bit process. This also affects the accuracy of any waveform measurement.

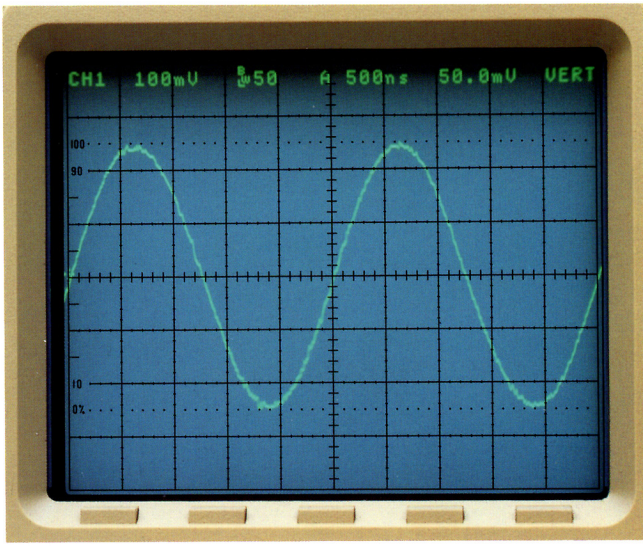

Is the repetitive bandwidth high enough?

It is important that your scope has a high enough bandwidth to let you see and measure the signals you encounter in your application.

Setup: Are the bandwidth and sample rate high enough for repetitive signals?

Attach the probe tip to	TP1
Set the scope for:	
Input coupling	DC
Vertical sensitivity (Volts/div)	1 V/div
Time base (sec/div)	2 ns/div (if available, otherwise 5 ns)
Trigger:	
Slope (+ or – edge)	+ (plus)
Coupling	DC
Level	1 V
Acquisition mode	Repetitive sampling mode ON

Repetitive bandwidth measures the oscilloscope's ability to acquire and display repetitive signals without significant distortion. The repetitive bandwidth of a DSO equals the bandwidth of the DSO's analog amplifiers and is independent of sample rate.

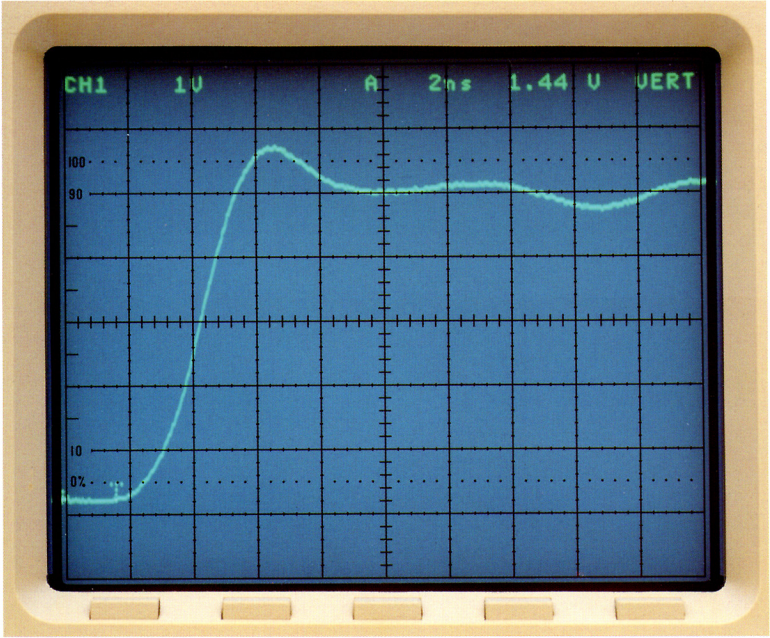

Repetitive (equivalent-time) sampling is appropriate for signals like this square wave. The rising edge should appear as in this photo.

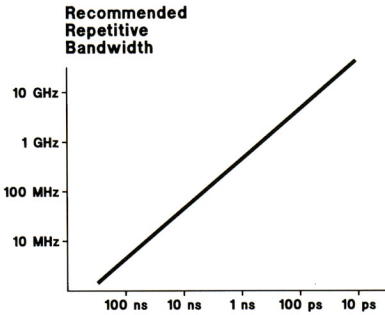

Fastest Risetimes for Repetitive Signals

This graph shows the approximate bandwidth that your oscilloscope needs to accurately acquire, display, and measure repetitive signals.

Is the single-shot bandwidth high enough?

Digitizing scopes are great for capturing and holding signals that occur only once in a while, but many DSOs have a single-shot bandwidth significantly less than their repetitive bandwidth.

Setup: Are the bandwidth and sample rate high enough for single-shot signals?

Attach the probe tip to	TP1
Set the scope for:	
Input coupling	DC
Vertical sensitivity (Volts/div)	1 V/div
Time base (sec/div)	2 ns/div (if available, otherwise 5 ns)
Trigger:	
Slope (+ or - edge)	+ (plus)
Coupling	DC
Level	1 V
Acquisition mode	Real-time sampling mode ON (Repetitive sampling mode OFF)

A high *single-shot bandwidth* allows a scope to faithfully capture a single event such as a fast ECL edge or a high speed laser pulse. Unlike repetitive bandwidth, single-shot bandwidth depends on the sample rate of the DSO. If the single-shot bandwidth is too low, waveform detail is compromised or lost altogether.

What about *sample rate*? The higher the better, right? Yes, but this specification by itself won't ensure that you get the measurement results you want. A DSO with a high sample rate, but low vertical resolution and no peak detection will not reveal as much waveform detail as one that combines these features with a lower sampling rate.

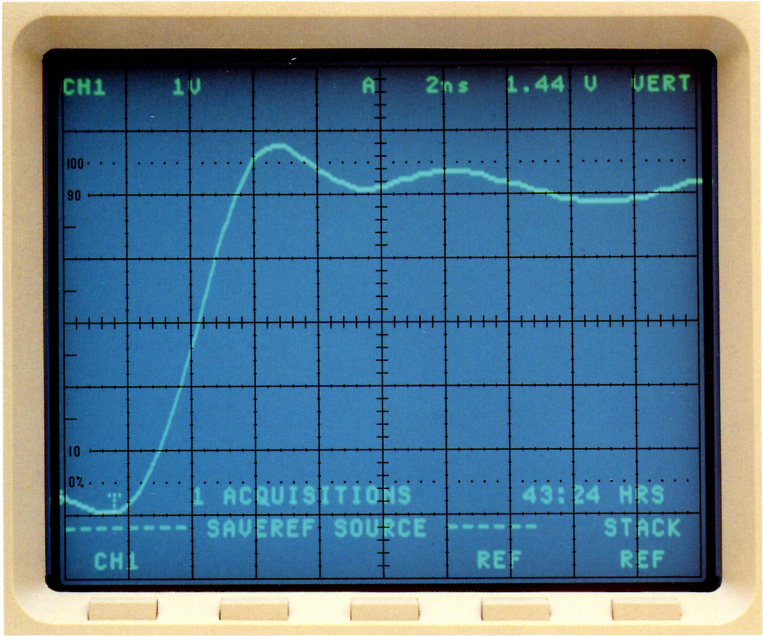

When repetitive (equivalent-time) sampling is turned off and the DSO is doing real-time sampling, the single-shot bandwidth determines the scope's rise time. If the single-shot bandwidth is significantly lower than the repetitive bandwidth, you will notice a longer rise time and perhaps even a waveshape that no longer matches that of the live signal.

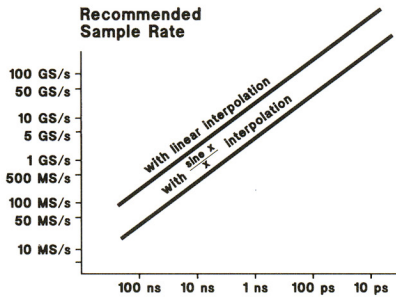

Fastest Risetimes for Single-Shot Signals

This graph indicates the approximate sample (digitizing) rate that you should use to accurately acquire, display, and measure single-shot signals.

A Choice of Packages

From the fastest to the smallest—Tektronix offers the widest selection of oscilloscopes in the world today.

If you need a hand-held digitizing oscilloscope, consider the Tektronix 222 10-MHz Miniscope. For the highest level of performance in waveform capture, processing, and analysis, there's the new Tektronix 600 Series Digitizing Signal Analyzer. And if your requirement is high performance in a compact, portable package, the Tektronix 2400 Series Digital Storage Oscilloscopes are the ideal choice.

A Choice of Technologies Too

Digital or Analog, Tektronix also offers you the widest selection of technologies, and each Tektronix scope is backed by more experience and technical support than any other manufacturer in the world.

For the greatest selection of products and the full support of the world's leading oscilloscope maker, come to Tektronix. Contact your Tek Sales Engineer for a complete review of your oscilloscope needs.

For further information contact:

***U.S.A., Asia, Australia,
Central and South America,
Japan***

Tektronix, Inc.
P.O. Box 1700
Beaverton, Oregon 97075
For the address and phone
number of the Tektronix Sales
Office nearest you, contact:
(800) 835-9433 x170
TWX: (910) 467-8708
TLX: 151754

Europe, Africa, Middle East

Tektronix Europe B.V.
P.O. Box 406
2130AK Hoofddorp
The Netherlands
Phone: (2503) 15644
Telex: 74876/74886

Canada

Tektronix Canada Inc.
P.O. Box 6500
Barrie, Ontario L4M-4V3
Phone: (705) 737-2700

Tektronix[®]
COMMITTED TO EXCELLENCE